

Type	: Rechargeable Nickel Metal Hydride Cylindrical Cell
Nominal Dimension (with Sleeve)	: 15.7mm(l) x 26.5mm(w) x 48.5mm(h)
Applications	: Recommended discharge current 17 to 510mA
Nominal Voltage	: 8.4V
Capacity	: Nominal: 170mAh Minimum: 170mAh Typical: 175mAh When discharged at 34mA to 7.0V at 20°C
Charging Condition	: 17mA for 16 hrs at 20°C
Fast Charge	: 85mA to 170mA (0.5 to 1C) charge termination control recommended control parameters: -ΔV : 0-5mV **DT/dt : 0.8°C/min (0.5 to 0.9C) 0.8 - 1°C/min (1C) **TCO : 45 - 50°C **Timer : 105% nominal input ** for ref. only
Service Life	: >500 cycles (IEC standard) Up to 1000 cycle (not less than 60% of nominal at 0.1C charge / 0.2C discharge)
Continuous Overcharge	: 17mA maximum current for 1 year. No conspicuous deformation and/or leakage
Weight	: 32.0g
Internal Resistance	: Maximum 2000mΩ upon fully charged at 1000Hz
Max. Charging Voltage	: 10.5V at 17mA charging
Ambient Temperature Range	: Standard Charge : 0 to 45°C Fast Charging : 10 to 45°C Discharge : -20 to 50°C Storage : -20 to 35°C

Model No.: **GP17R8H**

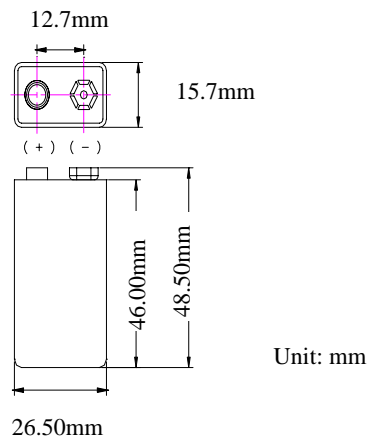

Low Rate Discharge

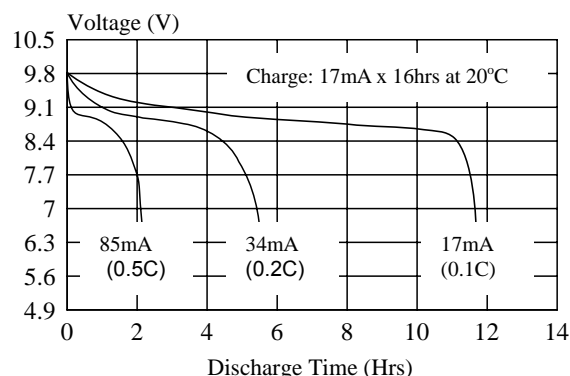

Fast Charge (Charge control required)

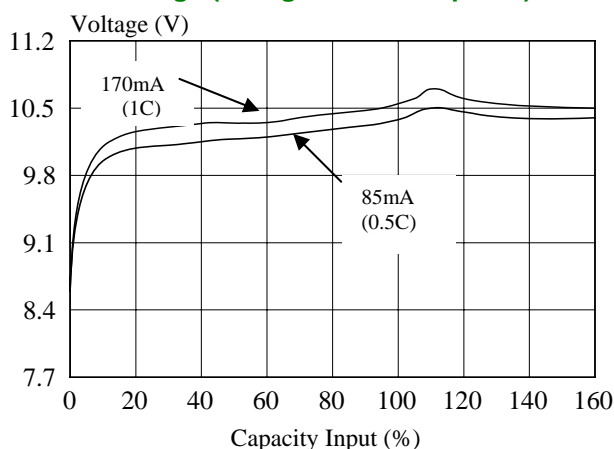

High Rate Discharge

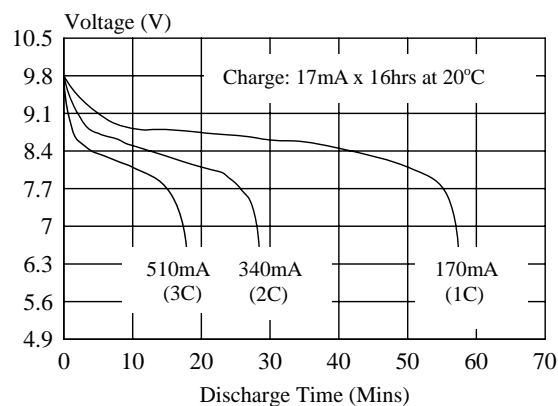

The information (subject to change without prior notice) contained in this document is for reference only and should not be used as a basis for product guarantee or warranty. For applications other than those described here, please consult your nearest GP Sales and Marketing Office or Distributors.